

Tempo

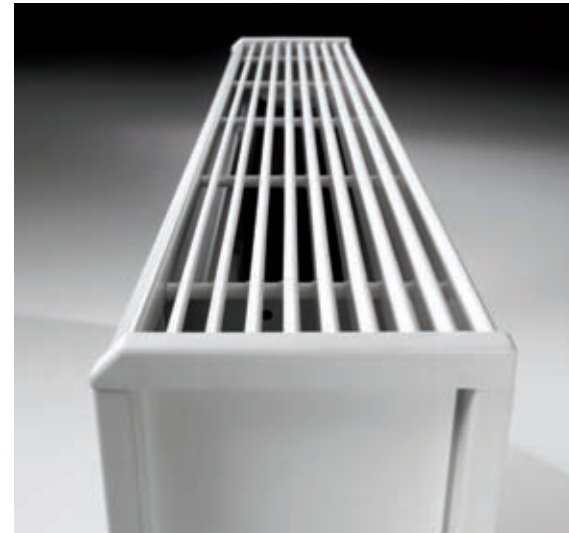



1. Optional top valve
2. Rounded synthetic corner pieces
3. Free-standing model
4. Thermostatic valve is totally concealed

Tempo_Dimensions

LOW
H₂O **30**
YEARS GUARANTEE



TEMW_Tempo Wall

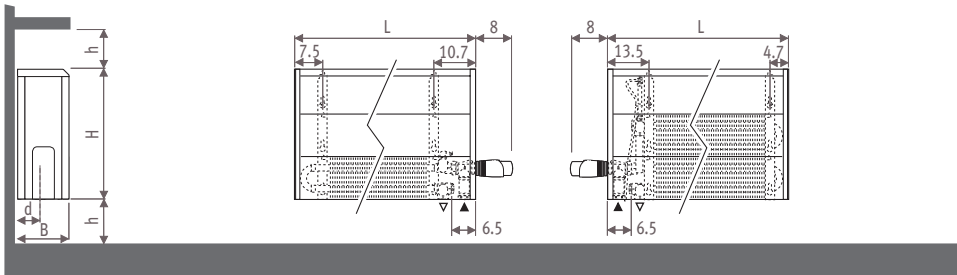

Dimensions in cm

| Type | B | d | BS | h/min* |
|-------|------|------|----|--------|
| 10-11 | 11.8 | 5.3 | 13 | 10 |
| 15-16 | 16.8 | 7.8 | 18 | 12 |
| 20-21 | 21.8 | 10.3 | 23 | 15 |

* Smaller dimensions can decrease output.

TEMF_Tempo Free-standing

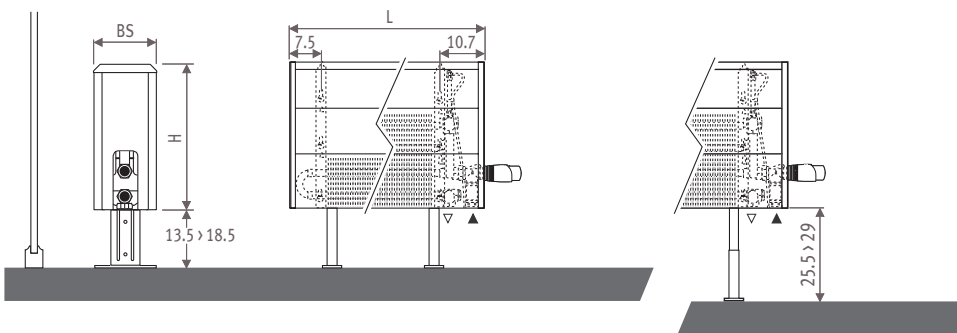

Connections

Jaga Comap valve to the wall

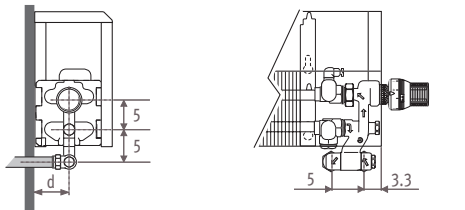

Jaga Comap valve to the floor

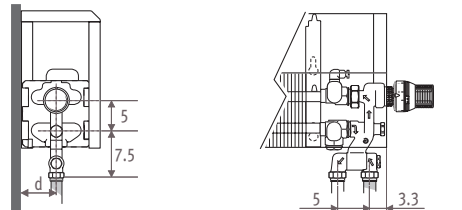

The valves offered by Jaga are totally concealed within the standard casing. Other valves may be partially visible. Detailed info: see Connection sets and valves.

Jaga Pro valve to the wall

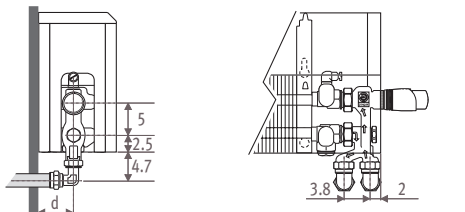

Jaga Pro valve to the floor

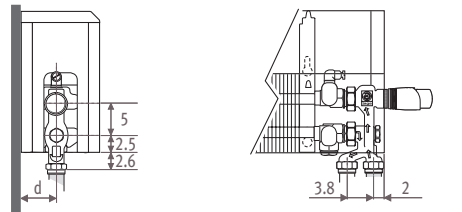

Jaga valve to the wall

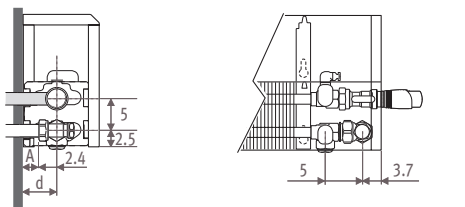

Jaga valve to the floor

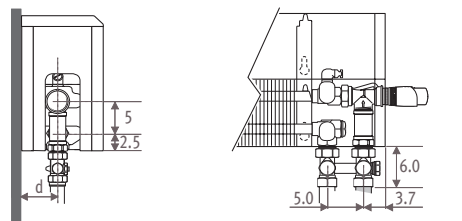

| Type | d | A |
|-------|------|-----|
| 10-11 | 5.3 | 2.9 |
| 15-16 | 7.8 | 5.3 |
| 20-21 | 10.3 | 7.9 |

Tempo_Options

Extended air vent



For easy and rapid venting.
Extended air vent for heat exchanger type 10, 15 and 20.
Standard delivered with type 11, 16 and 21.

| CODE | H casing |
|-------------|----------|
| 5090.114078 | 20 |
| 5090.114178 | 30 |
| 5090.114278 | 40 |
| 5090.114378 | 50+60 |
| 5090.114528 | 70 |
| 5090.114728 | 90 |

Top valve

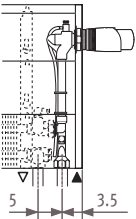

When ordering a top valve, add to the code of the Tempo /30 (top left) or /60 (top right).
Ex.: TEMW. 030 040 21.101/60

| CODE | H casing |
|-----------------------------|----------|
| Tempo wall: | |
| 5090.1300101 right | 30 |
| 5090.1300102 left | 30 |
| 5090.1300301 right | 40 |
| 5090.1300302 left | 40 |
| 5090.1300500 right and left | 50 |
| 5090.1300700 right and left | 60 |
| 5090.1300900 right and left | 70 |
| 5090.1301100 right and left | 90 |
| Tempo free-standing: | |
| 5090.1300100 | 30 |
| 5090.1300300 | 40 |
| 5090.1300500 | 50 |

Thermostatic head not included: see Connection sets & valves page 178-179.

Brush

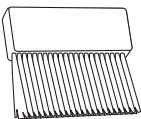

For easy cleaning of the underside of the Low-H₂O heat exchanger without detaching the casing.

| CODE |
|----------|
| 5090.001 |

Locks

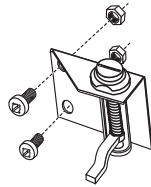

2 per casing. The casing cannot be detached without tools.

| CODE |
|----------|
| 5095.016 |

Free-standing model with feet in the colour of the appliance

The feet (standard in neutral grey lacquered) are also deliverable in the same colour as the apparatus. For this repeat the colour code after the code of the apparatus.
Ex.: TEMF. HHH LLL TT.101/101

| EXTRA CHARGE | | colour |
|---------------|----------|--------|
| Length casing | | |
| 040 > 120 | (2 feet) | |
| 140 > 220 | (3 feet) | |
| 240 > 300 | (4 feet) | |

Free-standing model with extended adjustable feet

- For extended feet in neutral grey, with a height of 25.5 to 29 cm, add /AL to the ordering code. Ex.: TEMF. 020 040 10. 101/AL
- For extended feet in the same colour as the casing, with a height of 25.5 to 29 cm, add /AL to the ordering code and repeat the colour code. Ex.: TEMF. 020 040 10. 101/AL/101

| EXTRA CHARGE | | |
|---------------|----------|-------------|
| Length casing | grey | colour |
| 040 > 120 | (2 feet) | 5,00 |
| 140 > 220 | (3 feet) | 7,40 |
| 240 > 300 | (4 feet) | 9,90 |

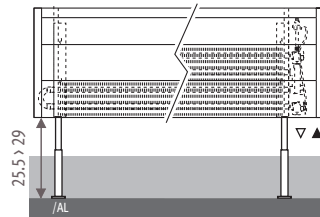

Fixing calorimeter holder

See Special Products.

DBE & Oxygen version

DBE: the smallest and most powerful radiator.

Oxygen: for healthy heat and clean air.
See price list "Top performers".

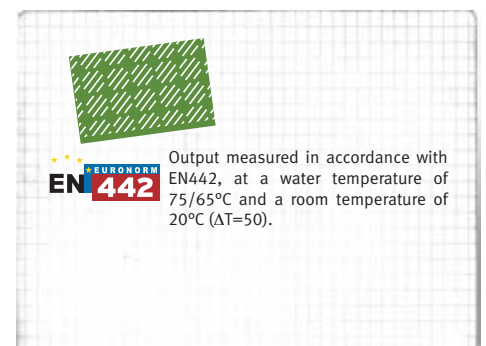

Tempo_Wall mounted model

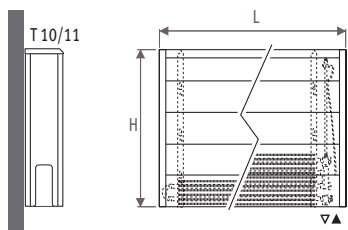

Standard delivery

- colour 101
- Low-H₂O heat exchanger type 10 or Twin type 11
- wall brackets
- complete casing
- fixing kit
- air vent 1/8": elbow (type 10) or extended (type 11)
- drain cock 1/2"

Connection

- standard connection: bottom end left or right, valve position 20 or 70
- for option top valve, add to the code of the Tempo /30 (top left) or /60 (top right)
- ex.: TEMW. 030 040 10.101/60
- for remote controlled valve: see Special products

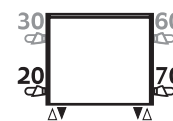

Wall mounted model_type 10

ORDERING CODE: TEMW. *code* *height* *length* *type* *colour*
020 040 10. 101

| H | | L 040 | 050 | 060 | 070 | 080 | 090 | 100 | 110 | 120 | 140 | 160 | 180 | 200 | 220 | 240 | 260 | 280 | 300 |
|-----|----------|-------|-----|------|------|------|------|------|------|------|------|------|------|------|------|------|------|------|------|
| 020 | 75/65/20 | 262 | 328 | 393 | 459 | 524 | 590 | 655 | 721 | 786 | 917 | 1048 | 1179 | 1310 | 1441 | 1572 | 1703 | 1834 | 1965 |
| | 90/70/20 | 339 | 424 | 508 | 594 | 678 | 763 | 847 | 933 | 1017 | 1186 | 1356 | 1525 | 1695 | 1864 | 2034 | 2203 | 2373 | 2542 |
| 030 | 75/65/20 | 330 | 413 | 496 | 578 | 661 | 743 | 826 | 909 | 991 | 1156 | 1322 | 1487 | 1652 | 1817 | 1982 | 2148 | 2313 | 2478 |
| | 90/70/20 | 426 | 533 | 641 | 746 | 854 | 960 | 1067 | 1174 | 1280 | 1493 | 1707 | 1920 | 2134 | 2347 | 2560 | 2774 | 2987 | 3200 |
| 040 | 75/65/20 | 385 | 482 | 578 | 674 | 770 | 867 | 963 | 1059 | 1156 | 1348 | 1541 | 1733 | 1926 | 2119 | 2311 | 2504 | 2696 | 2889 |
| | 90/70/20 | 496 | 621 | 745 | 869 | 993 | 1118 | 1242 | 1365 | 1491 | 1738 | 1987 | 2234 | 2483 | 2732 | 2980 | 3229 | 3476 | 3725 |
| 050 | 75/65/20 | 430 | 538 | 646 | 753 | 861 | 968 | 1076 | 1184 | 1291 | 1506 | 1722 | 1937 | 2152 | 2367 | 2582 | 2798 | 3013 | 3228 |
| | 90/70/20 | 554 | 693 | 832 | 969 | 1108 | 1246 | 1385 | 1524 | 1662 | 1939 | 2217 | 2493 | 2770 | 3047 | 3324 | 3602 | 3879 | 4155 |
| 060 | 75/65/20 | 468 | 585 | 702 | 819 | 936 | 1053 | 1170 | 1287 | 1404 | 1638 | 1872 | 2106 | 2340 | 2574 | 2808 | 3042 | 3276 | 3510 |
| | 90/70/20 | 601 | 752 | 902 | 1053 | 1203 | 1353 | 1504 | 1654 | 1804 | 2105 | 2406 | 2707 | 3007 | 3308 | 3609 | 3909 | 4210 | 4511 |
| 070 | 75/65/20 | 499 | 624 | 749 | 874 | 998 | 1123 | 1248 | 1373 | 1498 | 1747 | 1997 | 2246 | 2496 | 2746 | 2995 | 3245 | 3494 | 3744 |
| | 90/70/20 | 640 | 800 | 961 | 1121 | 1280 | 1441 | 1601 | 1761 | 1922 | 2241 | 2562 | 2881 | 3202 | 3523 | 3842 | 4163 | 4482 | 4803 |
| 090 | 75/65/20 | 548 | 685 | 821 | 958 | 1095 | 1232 | 1369 | 1506 | 1643 | 1917 | 2190 | 2464 | 2738 | 3012 | 3286 | 3559 | 3833 | 4107 |
| | 90/70/20 | 701 | 876 | 1050 | 1225 | 1400 | 1575 | 1750 | 1926 | 2101 | 2451 | 2800 | 3150 | 3501 | 3851 | 4201 | 4551 | 4901 | 5251 |

Wall mounted model Twin_type 11



ORDERING CODE: TEMW. *code* *height* *length* *type* *colour*
030 040 11. 101

| H | | L 040 | 050 | 060 | 070 | 080 | 090 | 100 | 110 | 120 | 140 | 160 | 180 | 200 | 220 | 240 | 260 | 280 | 300 |
|-----|----------|-------|------|------|------|------|------|------|------|------|------|------|------|------|------|------|------|------|------|
| 030 | 75/65/20 | 448 | 561 | 673 | 785 | 897 | 1009 | 1121 | 1233 | 1345 | 1569 | 1794 | 2018 | 2242 | 2466 | 2690 | 2915 | 3139 | 3363 |
| | 90/70/20 | 583 | 729 | 875 | 1021 | 1166 | 1312 | 1458 | 1603 | 1749 | 2040 | 2333 | 2624 | 2915 | 3206 | 3498 | 3790 | 4081 | 4373 |
| 040 | 75/65/20 | 506 | 632 | 758 | 885 | 1011 | 1138 | 1264 | 1390 | 1517 | 1770 | 2022 | 2275 | 2528 | 2781 | 3034 | 3286 | 3539 | 3792 |
| | 90/70/20 | 658 | 822 | 985 | 1150 | 1314 | 1479 | 1643 | 1807 | 1972 | 2301 | 2629 | 2957 | 3286 | 3615 | 3944 | 4272 | 4601 | 4930 |
| 050 | 75/65/20 | 554 | 693 | 832 | 970 | 1109 | 1247 | 1386 | 1525 | 1663 | 1940 | 2218 | 2495 | 2772 | 3049 | 3326 | 3604 | 3881 | 4158 |
| | 90/70/20 | 720 | 901 | 1081 | 1261 | 1441 | 1621 | 1801 | 1982 | 2161 | 2522 | 2883 | 3243 | 3603 | 3963 | 4323 | 4684 | 5044 | 5404 |
| 060 | 75/65/20 | 598 | 747 | 896 | 1046 | 1195 | 1345 | 1494 | 1643 | 1793 | 2092 | 2390 | 2689 | 2988 | 3287 | 3586 | 3884 | 4183 | 4482 |
| | 90/70/20 | 777 | 971 | 1164 | 1359 | 1553 | 1748 | 1941 | 2135 | 2330 | 2719 | 3106 | 3494 | 3883 | 4272 | 4660 | 5047 | 5436 | 5824 |
| 070 | 75/65/20 | 636 | 795 | 954 | 1113 | 1272 | 1431 | 1590 | 1749 | 1908 | 2226 | 2544 | 2862 | 3180 | 3498 | 3816 | 4134 | 4452 | 4770 |
| | 90/70/20 | 826 | 1033 | 1240 | 1446 | 1653 | 1859 | 2066 | 2272 | 2479 | 2892 | 3305 | 3719 | 4132 | 4545 | 4958 | 5371 | 5784 | 6198 |
| 090 | 75/65/20 | 703 | 879 | 1055 | 1231 | 1406 | 1582 | 1758 | 1934 | 2110 | 2461 | 2813 | 3164 | 3516 | 3868 | 4219 | 4571 | 4922 | 5274 |
| | 90/70/20 | 913 | 1142 | 1370 | 1599 | 1826 | 2055 | 2283 | 2512 | 2740 | 3196 | 3654 | 4109 | 4567 | 5024 | 5480 | 5937 | 6393 | 6850 |

Tempo_Wall mounted model

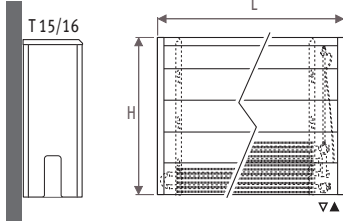

Standard delivery

- colour 101
- Low-H₂O heat exchanger type 15 or Twin type 16
- wall brackets
- complete casing
- fixing kit
- air vent 1/8": elbow (type 15) or extended (type 16)
- drain cock 1/2"

Connection

- standard connection: bottom end left or right, valve position 20 or 70
- for option top valve, add to the code of the Tempo /30 (top left) or /60 (top right)
- ex.: TEMW. 030 040 15.101/60
- for remote controlled valve: see Special products

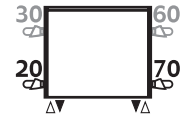

Wall mounted model_type 15

| | | ORDERING CODE: TEMW. | | | | | | | | | | | | | | | | | code | height | length | type | colour |
|-----|----------|----------------------|------|------|------|------|------|------|------|------|------|------|------|------|------|------|------|------|------|--------|--------|------|--------|
| | | | | | | | | | | | | | | | | | | | 020 | 040 | 15. | 101 | |
| H | | L | 040 | 050 | 060 | 070 | 080 | 090 | 100 | 110 | 120 | 140 | 160 | 180 | 200 | 220 | 240 | 260 | 280 | 300 | | | |
| 020 | 75/65/20 | | 436 | 545 | 654 | 763 | 872 | 981 | 1090 | 1199 | 1308 | 1526 | 1744 | 1962 | 2180 | 2398 | 2616 | 2834 | 3052 | 3270 | | | |
| | 90/70/20 | | 564 | 705 | 845 | 986 | 1127 | 1268 | 1409 | 1550 | 1691 | 1973 | 2254 | 2536 | 2818 | 3100 | 3382 | 3663 | 3945 | 4227 | | | |
| 030 | 75/65/20 | | 544 | 680 | 815 | 951 | 1087 | 1223 | 1359 | 1495 | 1631 | 1903 | 2174 | 2446 | 2718 | 2990 | 3262 | 3533 | 3805 | 4077 | | | |
| | 90/70/20 | | 702 | 877 | 1051 | 1227 | 1402 | 1577 | 1753 | 1928 | 2104 | 2455 | 2804 | 3155 | 3506 | 3857 | 4207 | 4557 | 4908 | 5259 | | | |
| 040 | 75/65/20 | | 627 | 784 | 941 | 1098 | 1254 | 1411 | 1568 | 1725 | 1882 | 2195 | 2509 | 2822 | 3136 | 3450 | 3763 | 4077 | 4390 | 4704 | | | |
| | 90/70/20 | | 807 | 1009 | 1211 | 1413 | 1614 | 1816 | 2018 | 2221 | 2423 | 2826 | 3230 | 3633 | 4037 | 4441 | 4844 | 5248 | 5651 | 6055 | | | |
| 050 | 75/65/20 | | 694 | 867 | 1040 | 1214 | 1387 | 1561 | 1734 | 1907 | 2081 | 2428 | 2774 | 3121 | 3468 | 3815 | 4162 | 4508 | 4855 | 5202 | | | |
| | 90/70/20 | | 891 | 1114 | 1336 | 1559 | 1782 | 2005 | 2227 | 2449 | 2673 | 3119 | 3563 | 4009 | 4454 | 4900 | 5346 | 5790 | 6236 | 6682 | | | |
| 060 | 75/65/20 | | 746 | 933 | 1120 | 1306 | 1493 | 1679 | 1866 | 2053 | 2239 | 2612 | 2986 | 3359 | 3732 | 4105 | 4478 | 4852 | 5225 | 5598 | | | |
| | 90/70/20 | | 956 | 1196 | 1435 | 1674 | 1913 | 2152 | 2392 | 2631 | 2870 | 3348 | 3827 | 4305 | 4783 | 5261 | 5739 | 6219 | 6697 | 7175 | | | |
| 070 | 75/65/20 | | 789 | 986 | 1183 | 1380 | 1578 | 1775 | 1972 | 2169 | 2366 | 2761 | 3155 | 3550 | 3944 | 4338 | 4733 | 5127 | 5522 | 5916 | | | |
| | 90/70/20 | | 1009 | 1261 | 1513 | 1765 | 2018 | 2270 | 2522 | 2774 | 3026 | 3532 | 4035 | 4541 | 5045 | 5549 | 6054 | 6558 | 7063 | 7567 | | | |
| 090 | 75/65/20 | | 848 | 1060 | 1272 | 1484 | 1696 | 1908 | 2120 | 2332 | 2544 | 2968 | 3392 | 3816 | 4240 | 4664 | 5088 | 5512 | 5936 | 6360 | | | |
| | 90/70/20 | | 1080 | 1350 | 1620 | 1890 | 2160 | 2430 | 2700 | 2970 | 3240 | 3780 | 4320 | 4860 | 5400 | 5940 | 6479 | 7019 | 7559 | 8099 | | | |

Wall mounted model Twin_type 16



| | | ORDERING CODE: TEMW. | | | | | | | | | | | | | | | | | code | height | length | type | colour |
|-----|----------|----------------------|------|------|------|------|------|------|------|------|------|------|------|------|------|------|------|------|------|--------|--------|------|--------|
| | | | | | | | | | | | | | | | | | | | 030 | 040 | 16. | 101 | |
| H | | L | 040 | 050 | 060 | 070 | 080 | 090 | 100 | 110 | 120 | 140 | 160 | 180 | 200 | 220 | 240 | 260 | 280 | 300 | | | |
| 030 | 75/65/20 | | 592 | 740 | 888 | 1036 | 1184 | 1332 | 1480 | 1628 | 1776 | 2072 | 2368 | 2664 | 2960 | 3256 | 3552 | 3848 | 4144 | 4440 | | | |
| | 90/70/20 | | 772 | 965 | 1158 | 1351 | 1544 | 1737 | 1930 | 2123 | 2316 | 2702 | 3088 | 3474 | 3860 | 4246 | 4632 | 5018 | 5404 | 5790 | | | |
| 040 | 75/65/20 | | 680 | 850 | 1020 | 1190 | 1360 | 1530 | 1700 | 1870 | 2040 | 2380 | 2720 | 3060 | 3400 | 3740 | 4080 | 4420 | 4760 | 5100 | | | |
| | 90/70/20 | | 887 | 1109 | 1331 | 1553 | 1775 | 1997 | 2218 | 2440 | 2662 | 3106 | 3550 | 3993 | 4437 | 4881 | 5324 | 5768 | 6212 | 6655 | | | |
| 050 | 75/65/20 | | 759 | 949 | 1139 | 1329 | 1518 | 1708 | 1898 | 2088 | 2278 | 2657 | 3037 | 3416 | 3796 | 4176 | 4555 | 4935 | 5314 | 5694 | | | |
| | 90/70/20 | | 991 | 1239 | 1487 | 1736 | 1982 | 2231 | 2479 | 2727 | 2975 | 3470 | 3966 | 4461 | 4957 | 5454 | 5949 | 6445 | 6940 | 7436 | | | |
| 060 | 75/65/20 | | 834 | 1042 | 1250 | 1459 | 1667 | 1876 | 2084 | 2292 | 2501 | 2918 | 3334 | 3751 | 4168 | 4585 | 5002 | 5418 | 5835 | 6252 | | | |
| | 90/70/20 | | 1090 | 1362 | 1634 | 1907 | 2179 | 2452 | 2724 | 2995 | 3269 | 3813 | 4357 | 4902 | 5447 | 5992 | 6537 | 7081 | 7626 | 8171 | | | |
| 070 | 75/65/20 | | 904 | 1130 | 1356 | 1582 | 1808 | 2034 | 2260 | 2486 | 2712 | 3164 | 3616 | 4068 | 4520 | 4972 | 5424 | 5876 | 6328 | 6780 | | | |
| | 90/70/20 | | 1182 | 1478 | 1773 | 2069 | 2365 | 2660 | 2956 | 3251 | 3547 | 4138 | 4729 | 5320 | 5911 | 6503 | 7094 | 7685 | 8276 | 8867 | | | |
| 090 | 75/65/20 | | 1038 | 1298 | 1558 | 1817 | 2077 | 2336 | 2596 | 2856 | 3115 | 3634 | 4154 | 4673 | 5192 | 5711 | 6230 | 6750 | 7269 | 7788 | | | |
| | 90/70/20 | | 1360 | 1700 | 2041 | 2380 | 2720 | 3060 | 3400 | 3741 | 4080 | 4760 | 5441 | 6120 | 6800 | 7480 | 8160 | 8841 | 9521 | 10200 | | | |

Tempo_Wall mounted model

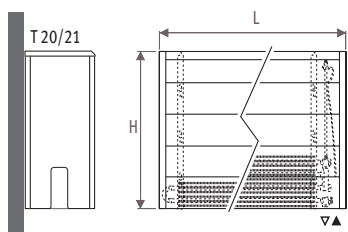

Standard delivery

- colour 101
- Low-H₂O heat exchanger type 20 or Twin type 21
- wall brackets
- complete casing
- fixing kit
- air vent 1/8": elbow (type 20) or extended (type 21)
- drain cock 1/2"

Connection

- standard connection: bottom end left or right, valve position 20 or 70
- for option top valve, add to the code of the Tempo /30 (top left) or /60 (top right)
- ex.: TEMW. 030 040 20.101/60
- for remote controlled valve: see Special products

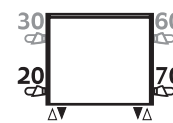

Wall mounted model_type 20

| | | ORDERING CODE: TEMW. | | | | | | | | | | | | | | | | code | height | length | type | colour |
|-----|----------|----------------------|------|------|------|------|------|------|------|------|------|------|------|------|------|------|------|-------|--------|--------|------|--------|
| | | | | | | | | | | | | | | | | | | 020 | 040 | 20. | 101 | |
| H | | L 040 | 050 | 060 | 070 | 080 | 090 | 100 | 110 | 120 | 140 | 160 | 180 | 200 | 220 | 240 | 260 | 280 | 300 | | | |
| 020 | 75/65/20 | 613 | 766 | 919 | 1072 | 1226 | 1379 | 1532 | 1685 | 1838 | 2145 | 2451 | 2758 | 3064 | 3370 | 3677 | 3983 | 4290 | 4596 | | | |
| | 90/70/20 | 792 | 990 | 1188 | 1386 | 1585 | 1783 | 1980 | 2178 | 2376 | 2773 | 3168 | 3565 | 3961 | 4356 | 4753 | 5149 | 5546 | 5941 | | | |
| 030 | 75/65/20 | 762 | 953 | 1144 | 1334 | 1525 | 1715 | 1906 | 2097 | 2287 | 2668 | 3050 | 3431 | 3812 | 4193 | 4574 | 4956 | 5337 | 5718 | | | |
| | 90/70/20 | 983 | 1229 | 1476 | 1721 | 1967 | 2212 | 2458 | 2705 | 2950 | 3441 | 3934 | 4425 | 4917 | 5408 | 5900 | 6392 | 6884 | 7375 | | | |
| 040 | 75/65/20 | 878 | 1098 | 1318 | 1537 | 1757 | 1976 | 2196 | 2416 | 2635 | 3074 | 3514 | 3953 | 4392 | 4831 | 5270 | 5710 | 6149 | 6588 | | | |
| | 90/70/20 | 1130 | 1413 | 1696 | 1978 | 2261 | 2543 | 2826 | 3109 | 3391 | 3956 | 4523 | 5088 | 5653 | 6218 | 6783 | 7349 | 7914 | 8479 | | | |
| 050 | 75/65/20 | 970 | 1213 | 1455 | 1698 | 1940 | 2183 | 2425 | 2668 | 2910 | 3395 | 3880 | 4365 | 4850 | 5335 | 5820 | 6305 | 6790 | 7275 | | | |
| | 90/70/20 | 1246 | 1558 | 1869 | 2181 | 2492 | 2804 | 3115 | 3427 | 3738 | 4361 | 4984 | 5607 | 6230 | 6853 | 7475 | 8098 | 8721 | 9344 | | | |
| 060 | 75/65/20 | 1043 | 1304 | 1565 | 1826 | 2086 | 2347 | 2608 | 2869 | 3130 | 3651 | 4173 | 4694 | 5216 | 5738 | 6259 | 6781 | 7302 | 7824 | | | |
| | 90/70/20 | 1337 | 1671 | 2006 | 2340 | 2673 | 3008 | 3343 | 3677 | 4012 | 4679 | 5348 | 6016 | 6685 | 7354 | 8022 | 8691 | 9359 | 10028 | | | |
| 070 | 75/65/20 | 1101 | 1377 | 1652 | 1927 | 2202 | 2478 | 2753 | 3028 | 3304 | 3854 | 4405 | 4955 | 5506 | 6057 | 6607 | 7158 | 7708 | 8259 | | | |
| | 90/70/20 | 1408 | 1761 | 2113 | 2464 | 2816 | 3169 | 3521 | 3872 | 4225 | 4929 | 5633 | 6337 | 7041 | 7746 | 8449 | 9154 | 9857 | 10562 | | | |
| 090 | 75/65/20 | 1183 | 1479 | 1774 | 2070 | 2366 | 2661 | 2957 | 3253 | 3548 | 4140 | 4731 | 5323 | 5914 | 6505 | 7097 | 7688 | 8280 | 8871 | | | |
| | 90/70/20 | 1507 | 1883 | 2259 | 2636 | 3013 | 3389 | 3766 | 4143 | 4518 | 5272 | 6025 | 6779 | 7531 | 8284 | 9038 | 9791 | 10544 | 11297 | | | |

Wall mounted model Twin_type 21



| | | ORDERING CODE: TEMW. | | | | | | | | | | | | | | | | code | height | length | type | colour |
|-----|----------|----------------------|------|------|------|------|------|------|------|------|------|------|------|------|-------|-------|-------|-------|--------|--------|------|--------|
| | | | | | | | | | | | | | | | | | | 030 | 040 | 21. | 101 | |
| H | | L 040 | 050 | 060 | 070 | 080 | 090 | 100 | 110 | 120 | 140 | 160 | 180 | 200 | 220 | 240 | 260 | 280 | 300 | | | |
| 030 | 75/65/20 | 779 | 974 | 1169 | 1364 | 1558 | 1753 | 1948 | 2143 | 2338 | 2727 | 3117 | 3506 | 3896 | 4286 | 4675 | 5065 | 5454 | 5844 | | | |
| | 90/70/20 | 1018 | 1273 | 1528 | 1783 | 2036 | 2291 | 2546 | 2801 | 3056 | 3564 | 4074 | 4582 | 5092 | 5601 | 6110 | 6619 | 7128 | 7637 | | | |
| 040 | 75/65/20 | 910 | 1137 | 1364 | 1592 | 1819 | 2047 | 2274 | 2501 | 2729 | 3184 | 3638 | 4093 | 4548 | 5003 | 5458 | 5912 | 6367 | 6822 | | | |
| | 90/70/20 | 1191 | 1488 | 1786 | 2084 | 2381 | 2680 | 2977 | 3274 | 3572 | 4168 | 4762 | 5358 | 5953 | 6549 | 7145 | 7739 | 8335 | 8930 | | | |
| 050 | 75/65/20 | 1033 | 1291 | 1549 | 1807 | 2066 | 2324 | 2582 | 2840 | 3098 | 3615 | 4131 | 4648 | 5164 | 5680 | 6197 | 6713 | 7230 | 7746 | | | |
| | 90/70/20 | 1354 | 1692 | 2031 | 2369 | 2708 | 3047 | 3385 | 3723 | 4061 | 4739 | 5416 | 6093 | 6770 | 7446 | 8124 | 8800 | 9478 | 10155 | | | |
| 060 | 75/65/20 | 1153 | 1441 | 1729 | 2017 | 2306 | 2594 | 2882 | 3170 | 3458 | 4035 | 4611 | 5188 | 5764 | 6340 | 6917 | 7493 | 8070 | 8646 | | | |
| | 90/70/20 | 1514 | 1892 | 2270 | 2648 | 3027 | 3406 | 3784 | 4162 | 4540 | 5297 | 6054 | 6811 | 7567 | 8324 | 9081 | 9837 | 10595 | 11351 | | | |
| 070 | 75/65/20 | 1271 | 1589 | 1906 | 2224 | 2542 | 2859 | 3177 | 3495 | 3812 | 4448 | 5083 | 5719 | 6354 | 6989 | 7625 | 8260 | 8896 | 9531 | | | |
| | 90/70/20 | 1671 | 2089 | 2506 | 2924 | 3342 | 3759 | 4177 | 4595 | 5012 | 5848 | 6683 | 7519 | 8354 | 9189 | 10025 | 10860 | 11696 | 12531 | | | |
| 090 | 75/65/20 | 1508 | 1885 | 2262 | 2639 | 3016 | 3393 | 3770 | 4147 | 4524 | 5278 | 6032 | 6786 | 7540 | 8294 | 9048 | 9802 | 10556 | 11310 | | | |
| | 90/70/20 | 1989 | 2486 | 2983 | 3480 | 3978 | 4475 | 4972 | 5469 | 5967 | 6961 | 7955 | 8950 | 9944 | 10939 | 11933 | 12927 | 13922 | 14916 | | | |

Tempo_Free-standing model

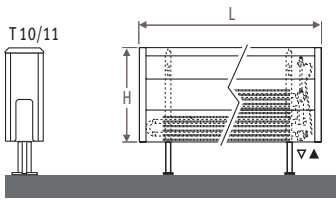

Standard delivery type 10

- colour 101
- Low-H₂O heat exchanger type 10
- brackets
- complete casing
- adjustable feet in neutral grey
- air vent elbow 1/8"
- drain cock 1/2"

Standard delivery type 11

- colour 101
- Twin Low-H₂O heat exchanger type 11
- brackets
- complete casing
- adjustable feet in neutral grey
- extended air vent 1/8"
- drain cock 1/2"

Connection

Top valve: add /30 (left) or /60 (right).
Ex.: TEMF. 030 040 10.101/60

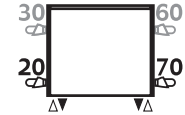

Free-standing model_type 10

| | | ORDERING CODE: TEMF. | | | | | | | | | | | | | | | | | |
|-----|----------|----------------------|-----|--------|-----|--------|------|------|------|--------|------|------|------|------|------|------|------|------|------|
| | | code | | height | | length | | type | | colour | | | | | | | | | |
| H | L | 040 | 050 | 060 | 070 | 080 | 090 | 100 | 110 | 120 | 140 | 160 | 180 | 200 | 220 | 240 | 260 | 280 | 300 |
| 020 | 75/65/20 | 262 | 328 | 393 | 459 | 524 | 590 | 655 | 721 | 786 | 917 | 1048 | 1179 | 1310 | 1441 | 1572 | 1703 | 1834 | 1965 |
| | 90/70/20 | 339 | 424 | 508 | 594 | 678 | 763 | 847 | 933 | 1017 | 1186 | 1356 | 1525 | 1695 | 1864 | 2034 | 2203 | 2373 | 2542 |
| 030 | 75/65/20 | 330 | 413 | 496 | 578 | 661 | 743 | 826 | 909 | 991 | 1156 | 1322 | 1487 | 1652 | 1817 | 1982 | 2148 | 2313 | 2478 |
| | 90/70/20 | 426 | 533 | 641 | 746 | 854 | 960 | 1067 | 1174 | 1280 | 1493 | 1707 | 1920 | 2134 | 2347 | 2560 | 2774 | 2987 | 3200 |
| 040 | 75/65/20 | 385 | 482 | 578 | 674 | 770 | 867 | 963 | 1059 | 1156 | 1348 | 1541 | 1733 | 1926 | 2119 | 2311 | 2504 | 2696 | 2889 |
| | 90/70/20 | 496 | 621 | 745 | 869 | 993 | 1118 | 1242 | 1365 | 1491 | 1738 | 1987 | 2234 | 2483 | 2732 | 2980 | 3229 | 3476 | 3725 |
| 050 | 75/65/20 | 430 | 538 | 646 | 753 | 861 | 968 | 1076 | 1184 | 1291 | 1506 | 1722 | 1937 | 2152 | 2367 | 2582 | 2798 | 3013 | 3228 |
| | 90/70/20 | 554 | 693 | 832 | 969 | 1108 | 1246 | 1385 | 1524 | 1662 | 1939 | 2217 | 2493 | 2770 | 3047 | 3324 | 3602 | 3879 | 4155 |

Free-standing model Twin_type 11



| | | ORDERING CODE: TEMF. | | | | | | | | | | | | | | | | | |
|-----|----------|----------------------|-----|--------|------|--------|------|------|------|--------|------|------|------|------|------|------|------|------|------|
| | | code | | height | | length | | type | | colour | | | | | | | | | |
| H | L | 040 | 050 | 060 | 070 | 080 | 090 | 100 | 110 | 120 | 140 | 160 | 180 | 200 | 220 | 240 | 260 | 280 | 300 |
| 030 | 75/65/20 | 448 | 561 | 673 | 785 | 897 | 1009 | 1121 | 1233 | 1345 | 1569 | 1794 | 2018 | 2242 | 2466 | 2690 | 2915 | 3139 | 3363 |
| | 90/70/20 | 583 | 729 | 875 | 1021 | 1166 | 1312 | 1458 | 1603 | 1749 | 2040 | 2333 | 2624 | 2915 | 3206 | 3498 | 3790 | 4081 | 4373 |
| 040 | 75/65/20 | 506 | 632 | 758 | 885 | 1011 | 1138 | 1264 | 1390 | 1517 | 1770 | 2022 | 2275 | 2528 | 2781 | 3034 | 3286 | 3539 | 3792 |
| | 90/70/20 | 658 | 822 | 985 | 1150 | 1314 | 1479 | 1643 | 1807 | 1972 | 2301 | 2629 | 2957 | 3286 | 3615 | 3944 | 4272 | 4601 | 4930 |
| 050 | 75/65/20 | 554 | 693 | 832 | 970 | 1109 | 1247 | 1386 | 1525 | 1663 | 1940 | 2218 | 2495 | 2772 | 3049 | 3326 | 3604 | 3881 | 4158 |
| | 90/70/20 | 720 | 901 | 1081 | 1261 | 1441 | 1621 | 1801 | 1982 | 2161 | 2522 | 2883 | 3243 | 3603 | 3963 | 4323 | 4684 | 5044 | 5404 |

Tempo_Free-standing model



48

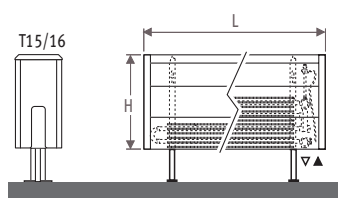

Standard delivery type 15

- colour 101
- Low-H₂O heat exchanger type 15
- brackets
- complete casing
- adjustable feet in neutral grey
- air vent elbow 1/8"
- drain cock 1/2"

Standard delivery type 16

- colour 101
- Twin Low-H₂O heat exchanger type 16
- brackets
- complete casing
- adjustable feet in neutral grey
- extended air vent 1/8"
- drain cock 1/2"

Connection

Top valve: add /30 (left) or /60 (right).

Ex.: TEMF. 030 040 15.101/60

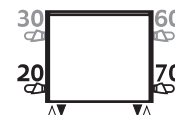

Free-standing model_type 15

ORDERING CODE: TEMF. *code* *height* *length* *type* *colour*
020 040 15. 101

| H | | L | 040 | 050 | 060 | 070 | 080 | 090 | 100 | 110 | 120 | 140 | 160 | 180 | 200 | 220 | 240 | 260 | 280 | 300 |
|-----|----------|-----|------|------|------|------|------|------|------|------|------|------|------|------|------|------|------|------|------|-----|
| 020 | 75/65/20 | 436 | 545 | 654 | 763 | 872 | 981 | 1090 | 1199 | 1308 | 1526 | 1744 | 1962 | 2180 | 2398 | 2616 | 2834 | 3052 | 3270 | |
| | 90/70/20 | 564 | 705 | 845 | 986 | 1127 | 1268 | 1409 | 1550 | 1691 | 1973 | 2254 | 2536 | 2818 | 3100 | 3382 | 3663 | 3945 | 4227 | |
| 030 | 75/65/20 | 544 | 680 | 815 | 951 | 1087 | 1223 | 1359 | 1495 | 1631 | 1903 | 2174 | 2446 | 2718 | 2990 | 3262 | 3533 | 3805 | 4077 | |
| | 90/70/20 | 702 | 877 | 1051 | 1227 | 1402 | 1577 | 1753 | 1928 | 2104 | 2455 | 2804 | 3155 | 3506 | 3857 | 4207 | 4557 | 4908 | 5259 | |
| 040 | 75/65/20 | 627 | 784 | 941 | 1098 | 1254 | 1411 | 1568 | 1725 | 1882 | 2195 | 2509 | 2822 | 3136 | 3450 | 3763 | 4077 | 4390 | 4704 | |
| | 90/70/20 | 807 | 1009 | 1211 | 1413 | 1614 | 1816 | 2018 | 2221 | 2423 | 2826 | 3230 | 3633 | 4037 | 4441 | 4844 | 5248 | 5651 | 6055 | |
| 050 | 75/65/20 | 694 | 867 | 1040 | 1214 | 1387 | 1561 | 1734 | 1907 | 2081 | 2428 | 2774 | 3121 | 3468 | 3815 | 4162 | 4508 | 4855 | 5202 | |
| | 90/70/20 | 891 | 1114 | 1336 | 1559 | 1782 | 2005 | 2227 | 2449 | 2673 | 3119 | 3563 | 4009 | 4454 | 4900 | 5346 | 5790 | 6236 | 6682 | |

Free-standing model Twin_type 16



ORDERING CODE: TEMF. *code* *height* *length* *type* *colour*
030 040 16. 101

| H | | L | 040 | 050 | 060 | 070 | 080 | 090 | 100 | 110 | 120 | 140 | 160 | 180 | 200 | 220 | 240 | 260 | 280 | 300 |
|-----|----------|-----|------|------|------|------|------|------|------|------|------|------|------|------|------|------|------|------|------|-----|
| 030 | 75/65/20 | 592 | 740 | 888 | 1036 | 1184 | 1332 | 1480 | 1628 | 1776 | 2072 | 2368 | 2664 | 2960 | 3256 | 3552 | 3848 | 4144 | 4440 | |
| | 90/70/20 | 772 | 965 | 1158 | 1351 | 1544 | 1737 | 1930 | 2123 | 2316 | 2702 | 3088 | 3474 | 3860 | 4246 | 4632 | 5018 | 5404 | 5790 | |
| 040 | 75/65/20 | 680 | 850 | 1020 | 1190 | 1360 | 1530 | 1700 | 1870 | 2040 | 2380 | 2720 | 3060 | 3400 | 3740 | 4080 | 4420 | 4760 | 5100 | |
| | 90/70/20 | 887 | 1109 | 1331 | 1553 | 1775 | 1997 | 2218 | 2440 | 2662 | 3106 | 3550 | 3993 | 4437 | 4881 | 5324 | 5768 | 6212 | 6655 | |
| 050 | 75/65/20 | 759 | 949 | 1139 | 1329 | 1518 | 1708 | 1898 | 2088 | 2278 | 2657 | 3037 | 3416 | 3796 | 4176 | 4555 | 4935 | 5314 | 5694 | |
| | 90/70/20 | 991 | 1239 | 1487 | 1736 | 1982 | 2231 | 2479 | 2727 | 2975 | 3470 | 3966 | 4461 | 4957 | 5454 | 5949 | 6445 | 6940 | 7436 | |

Tempo_Free-standing model

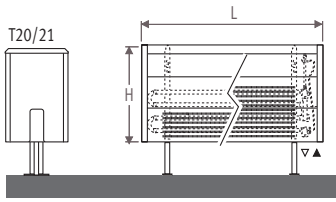

Standard delivery type 20

- colour 101
- Low-H₂O heat exchanger type 20
- brackets
- complete casing
- adjustable feet in neutral grey
- air vent elbow 1/8"
- drain cock 1/2"

Standard delivery type 21

- colour 101
- Twin Low-H₂O heat exchanger type 21
- brackets
- complete casing
- adjustable feet in neutral grey
- extended air vent 1/8"
- drain cock 1/2"

Connection

Top valve: add /30 (left) or /60 (right).
Ex.: TEMF. 030 040 20.101/60

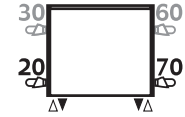

Free-standing model_type 20

| | | ORDERING CODE: TEMF. | | | | | | | | | | | | | | | | | code | height | length | type | colour |
|------------|----------|----------------------|------|------|------|------|------|------|------|------|------|------|------|------|------|------|------|------|------|--------|--------|------|--------|
| | | 040 | 050 | 060 | 070 | 080 | 090 | 100 | 110 | 120 | 140 | 160 | 180 | 200 | 220 | 240 | 260 | 280 | 300 | 020 | 040 | 20. | 101 |
| 020 | 75/65/20 | 613 | 766 | 919 | 1072 | 1226 | 1379 | 1532 | 1685 | 1838 | 2145 | 2451 | 2758 | 3064 | 3370 | 3677 | 3983 | 4290 | 4596 | | | | |
| | 90/70/20 | 792 | 990 | 1188 | 1386 | 1585 | 1783 | 1980 | 2178 | 2376 | 2773 | 3168 | 3565 | 3961 | 4356 | 4753 | 5149 | 5546 | 5941 | | | | |
| 030 | 75/65/20 | 762 | 953 | 1144 | 1334 | 1525 | 1715 | 1906 | 2097 | 2287 | 2668 | 3050 | 3431 | 3812 | 4193 | 4574 | 4956 | 5337 | 5718 | | | | |
| | 90/70/20 | 983 | 1229 | 1476 | 1721 | 1967 | 2212 | 2458 | 2705 | 2950 | 3441 | 3934 | 4425 | 4917 | 5408 | 5900 | 6392 | 6884 | 7375 | | | | |
| 040 | 75/65/20 | 878 | 1098 | 1318 | 1537 | 1757 | 1976 | 2196 | 2416 | 2635 | 3074 | 3514 | 3953 | 4392 | 4831 | 5270 | 5710 | 6149 | 6588 | | | | |
| | 90/70/20 | 1130 | 1413 | 1696 | 1978 | 2261 | 2543 | 2826 | 3109 | 3391 | 3956 | 4523 | 5088 | 5653 | 6218 | 6783 | 7349 | 7914 | 8479 | | | | |
| 050 | 75/65/20 | 970 | 1213 | 1455 | 1698 | 1940 | 2183 | 2425 | 2668 | 2910 | 3395 | 3880 | 4365 | 4850 | 5335 | 5820 | 6305 | 6790 | 7275 | | | | |
| | 90/70/20 | 1246 | 1558 | 1869 | 2181 | 2492 | 2804 | 3115 | 3427 | 3738 | 4361 | 4984 | 5607 | 6230 | 6853 | 7475 | 8098 | 8721 | 9344 | | | | |

Free-standing model Twin_type 21



| | | ORDERING CODE: TEMF. | | | | | | | | | | | | | | | | | code | height | length | type | colour |
|------------|----------|----------------------|------|------|------|------|------|------|------|------|------|------|------|------|------|------|------|------|-------|--------|--------|------|--------|
| | | 040 | 050 | 060 | 070 | 080 | 090 | 100 | 110 | 120 | 140 | 160 | 180 | 200 | 220 | 240 | 260 | 280 | 300 | 030 | 040 | 21. | 101 |
| 030 | 75/65/20 | 779 | 974 | 1169 | 1364 | 1558 | 1753 | 1948 | 2143 | 2338 | 2727 | 3117 | 3506 | 3896 | 4286 | 4675 | 5065 | 5454 | 5844 | | | | |
| | 90/70/20 | 1018 | 1273 | 1528 | 1783 | 2036 | 2291 | 2546 | 2801 | 3056 | 3564 | 4074 | 4582 | 5092 | 5601 | 6110 | 6619 | 7128 | 7637 | | | | |
| 040 | 75/65/20 | 910 | 1137 | 1364 | 1592 | 1819 | 2047 | 2274 | 2501 | 2729 | 3184 | 3638 | 4093 | 4548 | 5003 | 5458 | 5912 | 6367 | 6822 | | | | |
| | 90/70/20 | 1191 | 1488 | 1786 | 2084 | 2381 | 2680 | 2977 | 3274 | 3572 | 4168 | 4762 | 5358 | 5953 | 6549 | 7145 | 7739 | 8335 | 8930 | | | | |
| 050 | 75/65/20 | 1033 | 1291 | 1549 | 1807 | 2066 | 2324 | 2582 | 2840 | 3098 | 3615 | 4131 | 4648 | 5164 | 5680 | 6197 | 6713 | 7230 | 7746 | | | | |
| | 90/70/20 | 1354 | 1692 | 2031 | 2369 | 2708 | 3047 | 3385 | 3723 | 4061 | 4739 | 5416 | 6093 | 6770 | 7446 | 8124 | 8800 | 9478 | 10155 | | | | |