

Mini

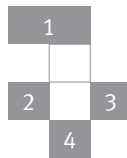



1. Free-standing model, colour white
2. Backwards profiled grille
3. Optional fixing set for tablet
4. Thermostatic valve is totally concealed



Mini_Dimensions

MINW_Mini Wall

MINF_Mini Free-standing

height 08

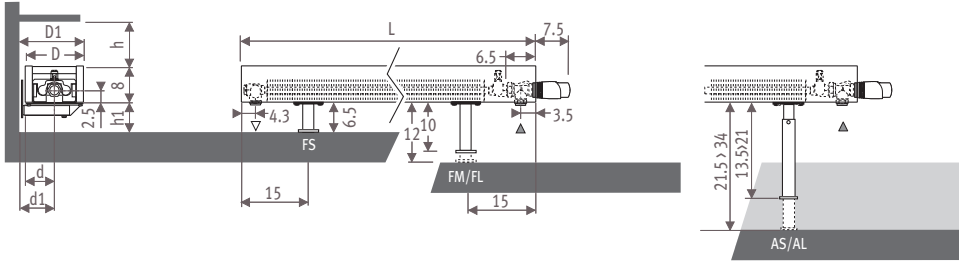

height 13 - 23 - 28

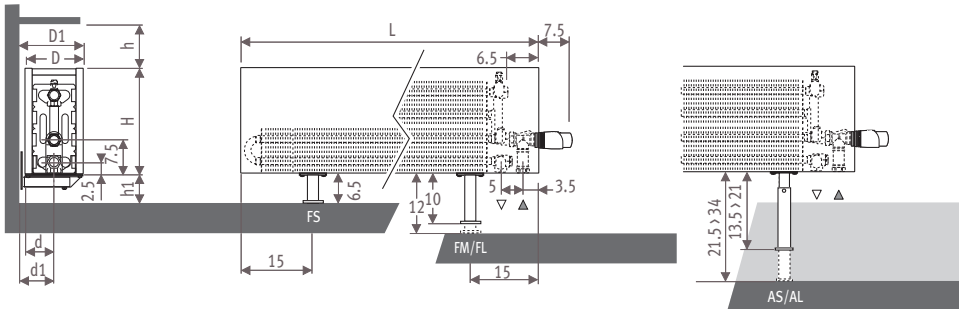

Feet:

FS = feet short : 6.5 cm

FM = feet medium : 10 cm

FL = feet long : 12 cm

AS = adjustable feet short : 13.5 > 21 cm

AL = adjustable feet long : 21.5 > 34 cm

Starting with length 180, 3 feet will be delivered.

Height 08_Dimensions in cm

| Type | D | D1 | d | d1 | h* | h1* |
|------|----|------|------|------|----|-----|
| 09 | 13 | 13.5 | 6.5 | 7.0 | 5 | 5 |
| 14 | 18 | 18.5 | 9.0 | 9.5 | 7 | 7 |
| 19 | 23 | 23.5 | 11.5 | 12.0 | 9 | 9 |

Height 13 - 23 - 28_Dimensions in cm

| Type | D | D1 | d | d1 | h* | h1* |
|-------|----|------|------|------|----|-----|
| 05/06 | 8 | 8.5 | 4.0 | 4.5 | 5 | 5 |
| 10/11 | 13 | 13.5 | 6.5 | 7.0 | 7 | 7 |
| 15/16 | 18 | 18.5 | 9.0 | 9.5 | 9 | 9 |
| 20/21 | 23 | 23.5 | 11.5 | 12.0 | 11 | 11 |

* Smaller dimensions can decrease output.

Connections

Jaga Comap valve to the wall

Jaga Comap valve to the floor

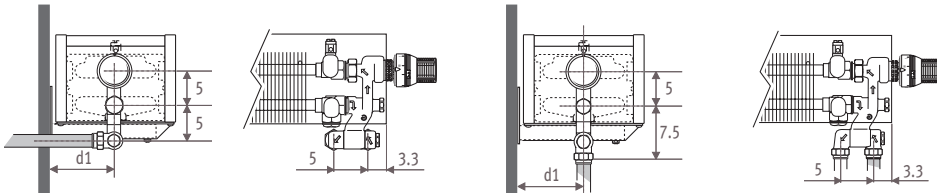

Jaga Pro valve to the wall

Jaga Pro valve to the floor

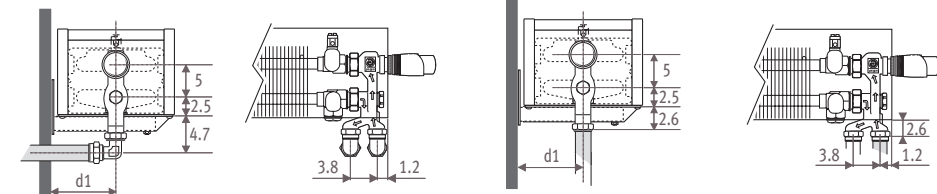

Jaga valve to the wall

Jaga valve to the floor

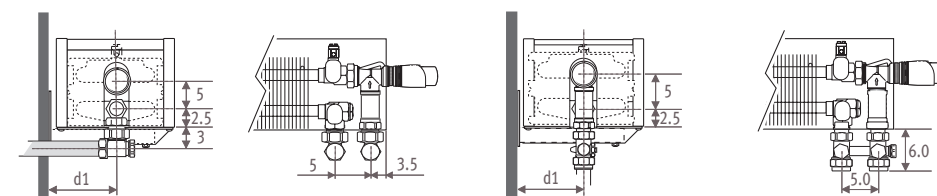

The valves offered by Jaga are totally concealed within the standard casing. Other valves may be partially visible. Detailed info: see Connection sets and valves.

Bench mounting set

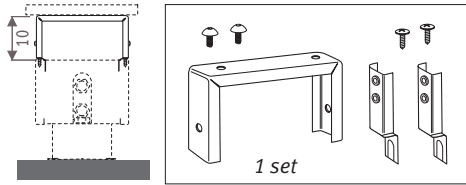

DBE

DBE: the smallest and most powerful radiator. See price list "Top performers".

| CODE | For type |
|------------------------|----------|
| standard colour | |
| 5210.00005/xxx | 05/06 |
| 5210.00010/xxx | 09/10/11 |
| 5210.00015/xxx | 14/15/16 |
| 5210.00020/xxx | 19/20/21 |
| other | |
| 5210.00005/xxx | 05/06 |
| 5210.00010/xxx | 09/10/11 |
| 5210.00015/xxx | 14/15/16 |
| 5210.00020/xxx | 19/20/21 |

fill in colour code

Number of sets for length casing:
 - from 060 to 160 cm: min. 2 sets
 - from 180 to 300 cm: min. 3 sets

Bench not supplied. .

Brush

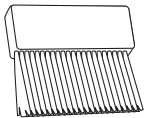

For easy cleaning of the underside of the Low-H₂O heat exchanger without detaching the casing.

| CODE |
|----------|
| 5090.001 |



Mini

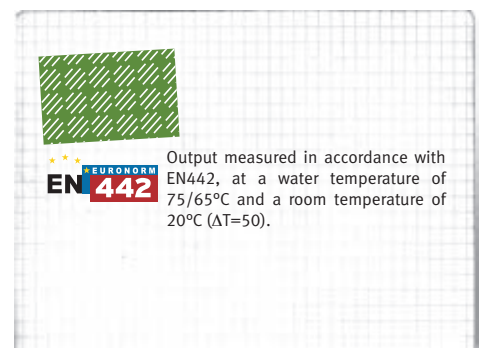

Mini_Wall mounted model

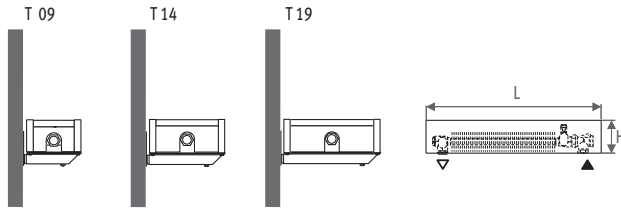

Standard delivery

- colour 101, 133 or 001
- Low-H₂O heat exchanger with other end connection, flow reversible L/R
- casing with wall fixings in the same colour
- chrome-plated air vent 1/8"
- drain cock 1/2"

Wall mounted model_height 8

ORDERING CODE: MINW. *code* *height* *length* *type* *colour*
008 008 060 09. xxx

| H | T | L | 060 | 070 | 080 | 090 | 100 | 110 | 120 | 140 | 160 | 180 | 200 | 220 | 240 | 260 | 280 | 300 |
|-----|----|----------|-----|-----|-----|------|------|------|------|------|------|------|------|------|------|------|------|------|
| 008 | 09 | 75/65/20 | 255 | 298 | 340 | 383 | 425 | 468 | 510 | 595 | 680 | 765 | 850 | 935 | 1020 | 1105 | 1190 | 1275 |
| | | 90/70/20 | 330 | 386 | 440 | 496 | 550 | 606 | 660 | 771 | 881 | 991 | 1101 | 1211 | 1321 | 1431 | 1541 | 1651 |
| 14 | 14 | 75/65/20 | 416 | 486 | 555 | 625 | 694 | 763 | 833 | 972 | 1110 | 1249 | 1388 | 1527 | 1666 | 1804 | 1943 | 2082 |
| | | 90/70/20 | 539 | 629 | 719 | 809 | 899 | 988 | 1079 | 1259 | 1437 | 1617 | 1797 | 1978 | 2158 | 2336 | 2516 | 2696 |
| 19 | 19 | 75/65/20 | 572 | 667 | 762 | 858 | 953 | 1048 | 1144 | 1334 | 1525 | 1715 | 1906 | 2097 | 2287 | 2478 | 2668 | 2859 |
| | | 90/70/20 | 741 | 864 | 987 | 1111 | 1234 | 1357 | 1482 | 1728 | 1975 | 2221 | 2468 | 2716 | 2962 | 3209 | 3455 | 3702 |

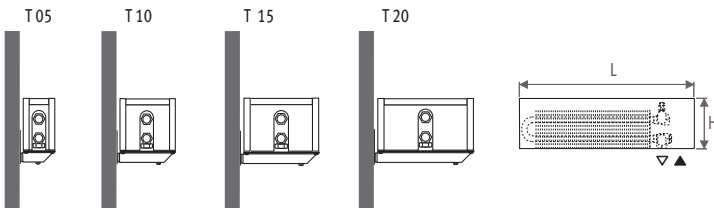

Standard delivery

- colour 101, 133 or 001
- Low-H₂O heat exchanger
- casing with wall fixings in the same colour
- chrome-plated air vent 1/8"
- drain cock 1/2"

Wall mounted model_height 13

ORDERING CODE: MINW. *code* *height* *length* *type* *colour*
013 013 060 05. xxx

| H | T | L | 060 | 070 | 080 | 090 | 100 | 110 | 120 | 140 | 160 | 180 | 200 | 220 | 240 | 260 | 280 | 300 |
|-----|----|----------|-----|------|------|------|------|------|------|------|------|------|------|------|------|------|------|------|
| 013 | 05 | 75/65/20 | 197 | 230 | 263 | 296 | 329 | 362 | 395 | 461 | 526 | 592 | 658 | 724 | 790 | 855 | 921 | 987 |
| | | 90/70/20 | 255 | 298 | 340 | 383 | 426 | 468 | 511 | 596 | 681 | 766 | 851 | 937 | 1022 | 1106 | 1192 | 1277 |
| 10 | 10 | 75/65/20 | 303 | 354 | 404 | 455 | 505 | 556 | 606 | 707 | 808 | 909 | 1010 | 1111 | 1212 | 1313 | 1414 | 1515 |
| | | 90/70/20 | 392 | 459 | 523 | 589 | 654 | 720 | 785 | 916 | 1047 | 1177 | 1308 | 1439 | 1570 | 1701 | 1832 | 1962 |
| 15 | 15 | 75/65/20 | 508 | 593 | 678 | 762 | 847 | 932 | 1016 | 1186 | 1355 | 1525 | 1694 | 1863 | 2033 | 2202 | 2372 | 2541 |
| | | 90/70/20 | 658 | 768 | 878 | 986 | 1096 | 1207 | 1315 | 1535 | 1754 | 1974 | 2193 | 2412 | 2632 | 2851 | 3071 | 3289 |
| 20 | 20 | 75/65/20 | 717 | 837 | 956 | 1076 | 1195 | 1315 | 1434 | 1673 | 1912 | 2151 | 2390 | 2629 | 2868 | 3107 | 3346 | 3585 |
| | | 90/70/20 | 928 | 1084 | 1238 | 1393 | 1547 | 1702 | 1856 | 2166 | 2475 | 2785 | 3094 | 3403 | 3713 | 4022 | 4332 | 4641 |

Mini_Wall mounted model

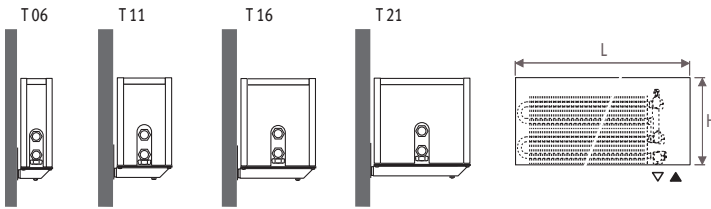

Standard delivery

- colour 101, 133 or 001
- Twin Low-H₂O heat exchanger
- casing with wall fixings in the same colour
- chrome-plated air vent 1/8"
- drain cock 1/2"

Wall mounted model Twin_height 23



ORDERING CODE: MINW. *code* height length type colour
023 060 06. xxx

| H | T | L | 060 | 070 | 080 | 090 | 100 | 110 | 120 | 140 | 160 | 180 | 200 | 220 | 240 | 260 | 280 | 300 |
|-----|----|----------|------|------|------|------|------|------|------|------|------|------|------|------|------|------|------|------|
| 023 | 06 | 75/65/20 | 323 | 377 | 431 | 485 | 539 | 593 | 647 | 755 | 862 | 970 | 1078 | 1186 | 1294 | 1401 | 1509 | 1617 |
| | | 90/70/20 | 418 | 488 | 557 | 627 | 697 | 767 | 837 | 976 | 1115 | 1255 | 1394 | 1534 | 1674 | 1812 | 1952 | 2091 |
| 11 | 11 | 75/65/20 | 601 | 701 | 802 | 902 | 1002 | 1102 | 1202 | 1403 | 1603 | 1804 | 2004 | 2204 | 2405 | 2605 | 2806 | 3006 |
| | | 90/70/20 | 782 | 912 | 1043 | 1173 | 1303 | 1433 | 1563 | 1825 | 2085 | 2346 | 2606 | 2866 | 3128 | 3388 | 3649 | 3909 |
| 16 | 16 | 75/65/20 | 785 | 916 | 1046 | 1177 | 1308 | 1439 | 1570 | 1831 | 2093 | 2354 | 2616 | 2878 | 3139 | 3401 | 3662 | 3924 |
| | | 90/70/20 | 1023 | 1194 | 1363 | 1534 | 1705 | 1875 | 2046 | 2386 | 2728 | 3068 | 3409 | 3751 | 4091 | 4433 | 4773 | 5114 |
| 21 | 21 | 75/65/20 | 1021 | 1191 | 1361 | 1531 | 1701 | 1871 | 2041 | 2381 | 2722 | 3062 | 3402 | 3742 | 4082 | 4423 | 4763 | 5103 |
| | | 90/70/20 | 1333 | 1555 | 1777 | 1999 | 2221 | 2443 | 2665 | 3109 | 3554 | 3998 | 4442 | 4886 | 5330 | 5775 | 6219 | 6663 |

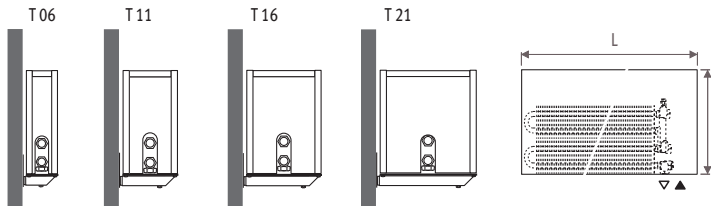

Standard delivery

- colour 101, 133 or 001
- Twin Low-H₂O heat exchanger
- casing with wall fixings in the same colour
- chrome-plated air vent 1/8"
- drain cock 1/2"

Wall mounted model Twin_height 28



ORDERING CODE: MINW. *code* height length type colour
028 060 06. xxx

| H | T | L | 060 | 070 | 080 | 090 | 100 | 110 | 120 | 140 | 160 | 180 | 200 | 220 | 240 | 260 | 280 | 300 |
|-----|----|----------|------|------|------|------|------|------|------|------|------|------|------|------|------|------|------|------|
| 028 | 06 | 75/65/20 | 342 | 399 | 456 | 513 | 570 | 627 | 684 | 798 | 912 | 1026 | 1140 | 1254 | 1368 | 1482 | 1596 | 1710 |
| | | 90/70/20 | 442 | 515 | 589 | 663 | 736 | 810 | 883 | 1031 | 1178 | 1325 | 1472 | 1620 | 1767 | 1914 | 2061 | 2208 |
| 11 | 11 | 75/65/20 | 653 | 762 | 871 | 980 | 1089 | 1198 | 1307 | 1525 | 1742 | 1960 | 2178 | 2396 | 2614 | 2831 | 3049 | 3267 |
| | | 90/70/20 | 849 | 991 | 1133 | 1274 | 1416 | 1558 | 1700 | 1983 | 2265 | 2549 | 2832 | 3116 | 3399 | 3682 | 3965 | 4249 |
| 16 | 16 | 75/65/20 | 860 | 1003 | 1146 | 1290 | 1433 | 1576 | 1720 | 2006 | 2293 | 2579 | 2866 | 3153 | 3439 | 3726 | 4012 | 4299 |
| | | 90/70/20 | 1121 | 1308 | 1494 | 1682 | 1868 | 2055 | 2243 | 2615 | 2990 | 3362 | 3737 | 4111 | 4484 | 4858 | 5231 | 5605 |
| 21 | 21 | 75/65/20 | 1127 | 1315 | 1503 | 1691 | 1879 | 2067 | 2255 | 2631 | 3006 | 3382 | 3758 | 4134 | 4510 | 4885 | 5261 | 5637 |
| | | 90/70/20 | 1473 | 1718 | 1964 | 2210 | 2455 | 2701 | 2946 | 3438 | 3928 | 4419 | 4910 | 5402 | 5893 | 6383 | 6874 | 7366 |

Mini_Fixed feet

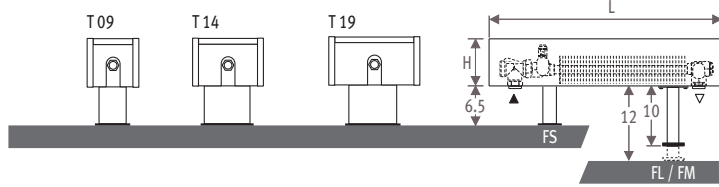

Standard delivery

- colour 101, 133 or 001
- Low-H₂O heat exchanger with other end connection, flow reversible L/R
- casing with wall fixings in the same colour
- chrome-plated air vent 1/8"
- drain cock 1/2"
- fixed feet FS, height 6.5 cm, in the same colour as the apparatus

- Other fixed feet - no surcharge:
- for feet with height 10 cm, ordering code /FM.
Ex.: MINF. 008 060 09. xxx /FM
 - for feet with height 12 cm, ordering code /FL.
Ex.: MINF. 008 060 09. xxx /FL

Free-standing model_height 8

ORDERING CODE: *code* MINF. *height* 008 *length* 060 *type* 09. *colour* xxx *foot* /FS

| H | T | L | 060 | 070 | 080 | 090 | 100 | 110 | 120 | 140 | 160 | 180 | 200 | 220 | 240 | 260 | 280 | 300 |
|-----|----|----------|-----|-----|-----|------|------|------|------|------|------|------|------|------|------|------|------|------|
| 008 | 09 | 75/65/20 | 255 | 298 | 340 | 383 | 425 | 468 | 510 | 595 | 680 | 765 | 850 | 935 | 1020 | 1105 | 1190 | 1275 |
| | | 90/70/20 | 330 | 386 | 440 | 496 | 550 | 606 | 660 | 771 | 881 | 991 | 1101 | 1211 | 1321 | 1431 | 1541 | 1651 |
| 14 | | 75/65/20 | 416 | 486 | 555 | 625 | 694 | 763 | 833 | 972 | 1110 | 1249 | 1388 | 1527 | 1666 | 1804 | 1943 | 2082 |
| | | 90/70/20 | 539 | 629 | 719 | 809 | 899 | 988 | 1079 | 1259 | 1437 | 1617 | 1797 | 1978 | 2158 | 2336 | 2516 | 2696 |
| 19 | | 75/65/20 | 572 | 667 | 762 | 858 | 953 | 1048 | 1144 | 1334 | 1525 | 1715 | 1906 | 2097 | 2287 | 2478 | 2668 | 2859 |
| | | 90/70/20 | 741 | 864 | 987 | 1111 | 1234 | 1357 | 1482 | 1728 | 1975 | 2221 | 2468 | 2716 | 2962 | 3209 | 3455 | 3702 |

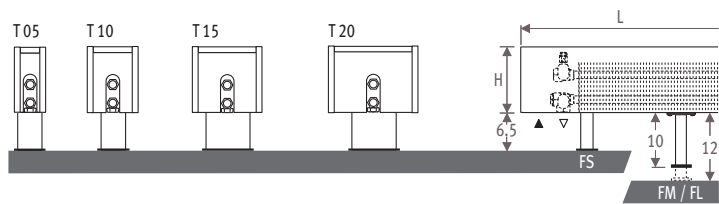

Standard delivery

- colour 101, 133 or 001
- Low-H₂O heat exchanger
- chrome-plated air vent 1/8"
- drain cock 1/2"
- fixed feet FS, height 6.5 cm, in the same colour as the apparatus

- Other fixed feet - no surcharge:
- for feet with height 10 cm, ordering code /FM.
Ex.: MINF. 013 060 05. xxx /FM
 - for feet with height 12 cm, ordering code /FL.
Ex.: MINF. 013 060 05. xxx /FL

Free-standing model_height 13

ORDERING CODE: *code* MINF. *height* 013 *length* 060 *type* 05. *colour* xxx *foot* /FS

| H | T | L | 060 | 070 | 080 | 090 | 100 | 110 | 120 | 140 | 160 | 180 | 200 | 220 | 240 | 260 | 280 | 300 |
|-----|----|----------|-----|------|------|------|------|------|------|------|------|------|------|------|------|------|------|------|
| 013 | 05 | 75/65/20 | 197 | 230 | 263 | 296 | 329 | 362 | 395 | 461 | 526 | 592 | 658 | 724 | 790 | 855 | 921 | 987 |
| | | 90/70/20 | 255 | 298 | 340 | 383 | 426 | 468 | 511 | 596 | 681 | 766 | 851 | 937 | 1022 | 1106 | 1192 | 1277 |
| 10 | | 75/65/20 | 303 | 354 | 404 | 455 | 505 | 556 | 606 | 707 | 808 | 909 | 1010 | 1111 | 1212 | 1313 | 1414 | 1515 |
| | | 90/70/20 | 392 | 459 | 523 | 589 | 654 | 720 | 785 | 916 | 1047 | 1177 | 1308 | 1439 | 1570 | 1701 | 1832 | 1962 |
| 15 | | 75/65/20 | 508 | 593 | 678 | 762 | 847 | 932 | 1016 | 1186 | 1355 | 1525 | 1694 | 1863 | 2033 | 2202 | 2372 | 2541 |
| | | 90/70/20 | 658 | 768 | 878 | 986 | 1096 | 1207 | 1315 | 1535 | 1754 | 1974 | 2193 | 2412 | 2632 | 2851 | 3071 | 3289 |
| 20 | | 75/65/20 | 717 | 837 | 956 | 1076 | 1195 | 1315 | 1434 | 1673 | 1912 | 2151 | 2390 | 2629 | 2868 | 3107 | 3346 | 3585 |
| | | 90/70/20 | 928 | 1084 | 1238 | 1393 | 1547 | 1702 | 1856 | 2166 | 2475 | 2785 | 3094 | 3403 | 3713 | 4022 | 4332 | 4641 |

Mini_Fixed feet

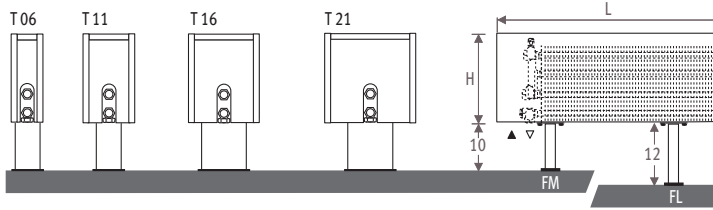

Standard delivery

- colour 133, 101 or 001
- Twin Low-H₂O heat exchanger
- chrome-plated air vent 1/8"
- drain cock 1/2"
- fixed feet FM, height 10 cm, in the same colour as the apparatus

Other fixed feet - no surcharge:
 - for feet with height 12 cm, ordering code /FL.
 Ex.: MINF. 023 060 06. xxx /FL

Free-standing model Twin_height 23



ORDERING CODE: MINF. *code* *height* *length* *type* *colour* *foot*
 023 06 060 06. xxx /FM

| H | T | L | 060 | 070 | 080 | 090 | 100 | 110 | 120 | 140 | 160 | 180 | 200 | 220 | 240 | 260 | 280 | 300 |
|-----|----|----------|------|------|------|------|------|------|------|------|------|------|------|------|------|------|------|------|
| 023 | 06 | 75/65/20 | 323 | 377 | 431 | 485 | 539 | 593 | 647 | 755 | 862 | 970 | 1078 | 1186 | 1294 | 1401 | 1509 | 1617 |
| | | 90/70/20 | 418 | 488 | 557 | 627 | 697 | 767 | 837 | 976 | 1115 | 1255 | 1394 | 1534 | 1674 | 1812 | 1952 | 2091 |
| 11 | 11 | 75/65/20 | 601 | 701 | 802 | 902 | 1002 | 1102 | 1202 | 1403 | 1603 | 1804 | 2004 | 2204 | 2405 | 2605 | 2806 | 3006 |
| | | 90/70/20 | 782 | 912 | 1043 | 1173 | 1303 | 1433 | 1563 | 1825 | 2085 | 2346 | 2606 | 2866 | 3128 | 3388 | 3649 | 3909 |
| 16 | 16 | 75/65/20 | 785 | 916 | 1046 | 1177 | 1308 | 1439 | 1570 | 1831 | 2093 | 2354 | 2616 | 2878 | 3139 | 3401 | 3662 | 3924 |
| | | 90/70/20 | 1023 | 1194 | 1363 | 1534 | 1705 | 1875 | 2046 | 2386 | 2728 | 3068 | 3409 | 3751 | 4091 | 4433 | 4773 | 5114 |
| 21 | 21 | 75/65/20 | 1021 | 1191 | 1361 | 1531 | 1701 | 1871 | 2041 | 2381 | 2722 | 3062 | 3402 | 3742 | 4082 | 4423 | 4763 | 5103 |
| | | 90/70/20 | 1333 | 1555 | 1777 | 1999 | 2221 | 2443 | 2665 | 3109 | 3554 | 3998 | 4442 | 4886 | 5330 | 5775 | 6219 | 6663 |

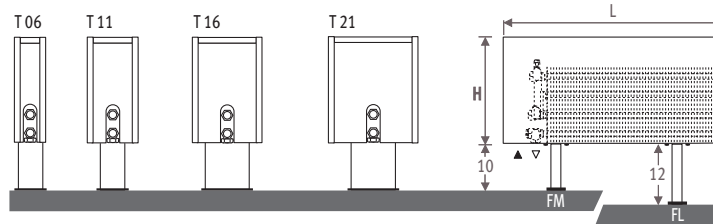

Standard delivery

- colour 133, 101 or 001
- Twin Low-H₂O heat exchanger
- chrome-plated air vent 1/8"
- drain cock 1/2"
- fixed feet FM, height 10 cm, in the same colour as the apparatus

Other fixed feet - no surcharge:
 - for feet with height 12 cm, ordering code /FL.
 Ex.: MINF. 028 060 06. xxx /FL



| H | T | L | 060 | 070 | 080 | 090 | 100 | 110 | 120 | 140 | 160 | 180 | 200 | 220 | 240 | 260 | 280 | 300 |
|-----|----|----------|------|------|------|------|------|------|------|------|------|------|------|------|------|------|------|------|
| 028 | 06 | 75/65/20 | 342 | 399 | 456 | 513 | 570 | 627 | 684 | 798 | 912 | 1026 | 1140 | 1254 | 1368 | 1482 | 1596 | 1710 |
| | | 90/70/20 | 442 | 515 | 589 | 663 | 736 | 810 | 883 | 1031 | 1178 | 1325 | 1472 | 1620 | 1767 | 1914 | 2061 | 2208 |
| 11 | 11 | 75/65/20 | 653 | 762 | 871 | 980 | 1089 | 1198 | 1307 | 1525 | 1742 | 1960 | 2178 | 2396 | 2614 | 2831 | 3049 | 3267 |
| | | 90/70/20 | 849 | 991 | 1133 | 1274 | 1416 | 1558 | 1700 | 1983 | 2265 | 2549 | 2832 | 3116 | 3399 | 3682 | 3965 | 4249 |
| 16 | 16 | 75/65/20 | 860 | 1003 | 1146 | 1290 | 1433 | 1576 | 1720 | 2006 | 2293 | 2579 | 2866 | 3153 | 3439 | 3726 | 4012 | 4299 |
| | | 90/70/20 | 1121 | 1308 | 1494 | 1682 | 1868 | 2055 | 2243 | 2615 | 2990 | 3362 | 3737 | 4111 | 4484 | 4858 | 5231 | 5605 |
| 21 | 21 | 75/65/20 | 1127 | 1315 | 1503 | 1691 | 1879 | 2067 | 2255 | 2631 | 3006 | 3382 | 3758 | 4134 | 4510 | 4885 | 5261 | 5637 |
| | | 90/70/20 | 1473 | 1718 | 1964 | 2210 | 2455 | 2701 | 2946 | 3438 | 3928 | 4419 | 4910 | 5402 | 5893 | 6383 | 6874 | 7366 |

Mini_Adjustable feet

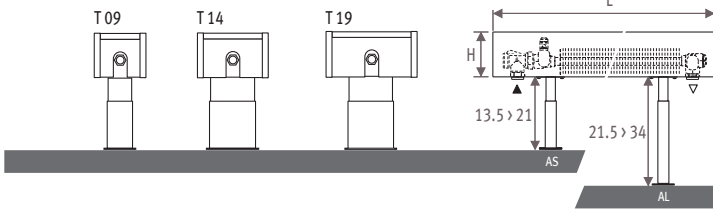

Standard delivery

- colour 101, 133 or 001
- Low-H₂O heat exchanger with other end connection, flow reversible L/R
- chrome-plated air vent 1/8"
- drain cock 1/2"
- adjustable feet AS, height from 13.5 to 21 cm, in the same colour as the apparatus

Other adjustable feet - no surcharge:
- for feet with height from 21.5 cm to 34 cm, ordering code /AL.
Ex.: MINF. 008 060 09. xxx /AL

Free-standing model_height 8

ORDERING CODE: MINF. *code* *height* *length* *type* *colour* *foot*
008 008 060 09. xxx /AS

| H | T | L | 060 | 070 | 080 | 090 | 100 | 110 | 120 | 140 | 160 | 180 | 200 | 220 | 240 | 260 | 280 | 300 |
|-----|----|----------|-----|-----|-----|------|------|------|------|------|------|------|------|------|------|------|------|------|
| 008 | 09 | 75/65/20 | 255 | 298 | 340 | 383 | 425 | 468 | 510 | 595 | 680 | 765 | 850 | 935 | 1020 | 1105 | 1190 | 1275 |
| | | 90/70/20 | 330 | 386 | 440 | 496 | 550 | 606 | 660 | 771 | 881 | 991 | 1101 | 1211 | 1321 | 1431 | 1541 | 1651 |
| 14 | | 75/65/20 | 416 | 486 | 555 | 625 | 694 | 763 | 833 | 972 | 1110 | 1249 | 1388 | 1527 | 1666 | 1804 | 1943 | 2082 |
| | | 90/70/20 | 539 | 629 | 719 | 809 | 899 | 988 | 1079 | 1259 | 1437 | 1617 | 1797 | 1978 | 2158 | 2336 | 2516 | 2696 |
| 19 | | 75/65/20 | 572 | 667 | 762 | 858 | 953 | 1048 | 1144 | 1334 | 1525 | 1715 | 1906 | 2097 | 2287 | 2478 | 2668 | 2859 |
| | | 90/70/20 | 741 | 864 | 987 | 1111 | 1234 | 1357 | 1482 | 1728 | 1975 | 2221 | 2468 | 2716 | 2962 | 3209 | 3455 | 3702 |

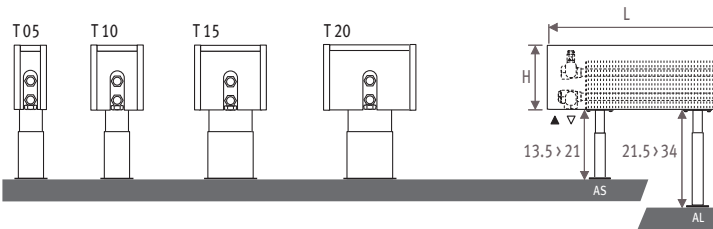

Standard delivery

- colour 101, 133 or 001
- Low-H₂O heat exchanger
- chrome-plated air vent 1/8"
- drain cock 1/2"
- adjustable feet AS, height from 13.5 to 21 cm, in the same colour as the apparatus

Other adjustable feet - no surcharge:
- for feet with height from 21.5 cm to 34 cm, ordering code /AL.
Ex.: MINF. 013 060 05. xxx /AL

Free-standing model_height 13

ORDERING CODE: MINF. *code* *height* *length* *type* *colour* *foot*
013 013 060 05. xxx /AS

| H | T | L | 060 | 070 | 080 | 090 | 100 | 110 | 120 | 140 | 160 | 180 | 200 | 220 | 240 | 260 | 280 | 300 |
|-----|----|----------|-----|------|------|------|------|------|------|------|------|------|------|------|------|------|------|------|
| 013 | 05 | 75/65/20 | 197 | 230 | 263 | 296 | 329 | 362 | 395 | 461 | 526 | 592 | 658 | 724 | 790 | 855 | 921 | 987 |
| | | 90/70/20 | 255 | 298 | 340 | 383 | 426 | 468 | 511 | 596 | 681 | 766 | 851 | 937 | 1022 | 1106 | 1192 | 1277 |
| 10 | | 75/65/20 | 303 | 354 | 404 | 455 | 505 | 556 | 606 | 707 | 808 | 909 | 1010 | 1111 | 1212 | 1313 | 1414 | 1515 |
| | | 90/70/20 | 392 | 459 | 523 | 589 | 654 | 720 | 785 | 916 | 1047 | 1177 | 1308 | 1439 | 1570 | 1701 | 1832 | 1962 |
| 15 | | 75/65/20 | 508 | 593 | 678 | 762 | 847 | 932 | 1016 | 1186 | 1355 | 1525 | 1694 | 1863 | 2033 | 2202 | 2372 | 2541 |
| | | 90/70/20 | 658 | 768 | 878 | 986 | 1096 | 1207 | 1315 | 1535 | 1754 | 1974 | 2193 | 2412 | 2632 | 2851 | 3071 | 3289 |
| 20 | | 75/65/20 | 717 | 837 | 956 | 1076 | 1195 | 1315 | 1434 | 1673 | 1912 | 2151 | 2390 | 2629 | 2868 | 3107 | 3346 | 3585 |
| | | 90/70/20 | 928 | 1084 | 1238 | 1393 | 1547 | 1702 | 1856 | 2166 | 2475 | 2785 | 3094 | 3403 | 3713 | 4022 | 4332 | 4641 |

Mini_Adjustable feet

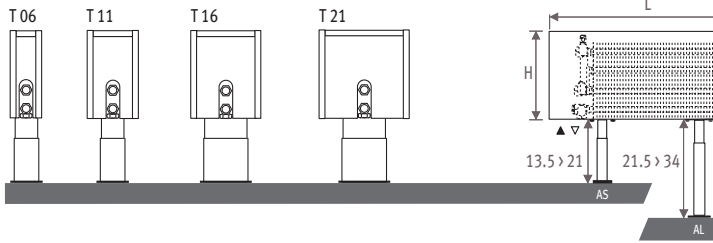

Standard delivery

- colour 101, 133 or 001
- Twin Low-H₂O heat exchanger
- chrome-plated air vent 1/8"
- drain cock 1/2"
- adjustable feet AS, height from 13.5 to 21 cm, in the same colour as the apparatus

Other adjustable feet - no surcharge:
 - for feet with height from 21.5 cm to 34 cm, ordering code /AL.
 Ex.: MINF. 023 060 06. xxx /AL

Free-standing model Twin_height 23



ORDERING CODE: *code* MINF. *height* 023 *length* 060 *type* 06. *colour* xxx *foot* /AS

| H | T | L | 060 | 070 | 080 | 090 | 100 | 110 | 120 | 140 | 160 | 180 | 200 | 220 | 240 | 260 | 280 | 300 |
|-----|----|----------|------|------|------|------|------|------|------|------|------|------|------|------|------|------|------|------|
| 023 | 06 | 75/65/20 | 323 | 377 | 431 | 485 | 539 | 593 | 647 | 755 | 862 | 970 | 1078 | 1186 | 1294 | 1401 | 1509 | 1617 |
| | | 90/70/20 | 418 | 488 | 557 | 627 | 697 | 767 | 837 | 976 | 1115 | 1255 | 1394 | 1534 | 1674 | 1812 | 1952 | 2091 |
| 11 | 11 | 75/65/20 | 601 | 701 | 802 | 902 | 1002 | 1102 | 1202 | 1403 | 1603 | 1804 | 2004 | 2204 | 2405 | 2605 | 2806 | 3006 |
| | | 90/70/20 | 782 | 912 | 1043 | 1173 | 1303 | 1433 | 1563 | 1825 | 2085 | 2346 | 2606 | 2866 | 3128 | 3388 | 3649 | 3909 |
| 16 | 16 | 75/65/20 | 785 | 916 | 1046 | 1177 | 1308 | 1439 | 1570 | 1831 | 2093 | 2354 | 2616 | 2878 | 3139 | 3401 | 3662 | 3924 |
| | | 90/70/20 | 1023 | 1194 | 1363 | 1534 | 1705 | 1875 | 2046 | 2386 | 2728 | 3068 | 3409 | 3751 | 4091 | 4433 | 4773 | 5114 |
| 21 | 21 | 75/65/20 | 1021 | 1191 | 1361 | 1531 | 1701 | 1871 | 2041 | 2381 | 2722 | 3062 | 3402 | 3742 | 4082 | 4423 | 4763 | 5103 |
| | | 90/70/20 | 1333 | 1555 | 1777 | 1999 | 2221 | 2443 | 2665 | 3109 | 3554 | 3998 | 4442 | 4886 | 5330 | 5775 | 6219 | 6663 |

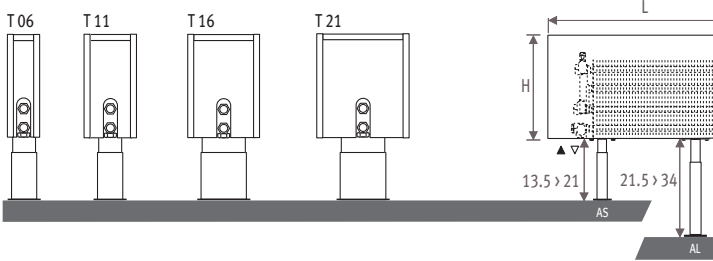

Standard delivery

- colour 101, 133 or 001
- Twin Low-H₂O heat exchanger
- chrome-plated air vent 1/8"
- drain cock 1/2"
- adjustable feet AS, height from 13.5 to 21 cm, in the same colour as the apparatus

Other adjustable feet - no surcharge:
 - for feet with height from 21.5 cm to 34 cm, ordering code /AL.
 Ex.: MINF. 028 060 06. xxx /AL

Free-standing model Twin_height 28



ORDERING CODE: *code* MINF. *height* 028 *length* 060 *type* 06. *colour* xxx *foot* /AS

| H | T | L | 060 | 070 | 080 | 090 | 100 | 110 | 120 | 140 | 160 | 180 | 200 | 220 | 240 | 260 | 280 | 300 |
|-----|----|----------|------|------|------|------|------|------|------|------|------|------|------|------|------|------|------|------|
| 028 | 06 | 75/65/20 | 342 | 399 | 456 | 513 | 570 | 627 | 684 | 798 | 912 | 1026 | 1140 | 1254 | 1368 | 1482 | 1596 | 1710 |
| | | 90/70/20 | 442 | 515 | 589 | 663 | 736 | 810 | 883 | 1031 | 1178 | 1325 | 1472 | 1620 | 1767 | 1914 | 2061 | 2208 |
| 11 | 11 | 75/65/20 | 653 | 762 | 871 | 980 | 1089 | 1198 | 1307 | 1525 | 1742 | 1960 | 2178 | 2396 | 2614 | 2831 | 3049 | 3267 |
| | | 90/70/20 | 849 | 991 | 1133 | 1274 | 1416 | 1558 | 1700 | 1983 | 2265 | 2549 | 2832 | 3116 | 3399 | 3682 | 3965 | 4249 |
| 16 | 16 | 75/65/20 | 860 | 1003 | 1146 | 1290 | 1433 | 1576 | 1720 | 2006 | 2293 | 2579 | 2866 | 3153 | 3439 | 3726 | 4012 | 4299 |
| | | 90/70/20 | 1121 | 1308 | 1494 | 1682 | 1868 | 2055 | 2243 | 2615 | 2990 | 3362 | 3737 | 4111 | 4484 | 4858 | 5231 | 5605 |
| 21 | 21 | 75/65/20 | 1127 | 1315 | 1503 | 1691 | 1879 | 2067 | 2255 | 2631 | 3006 | 3382 | 3758 | 4134 | 4510 | 4885 | 5261 | 5637 |
| | | 90/70/20 | 1473 | 1718 | 1964 | 2210 | 2455 | 2701 | 2946 | 3438 | 3928 | 4419 | 4910 | 5402 | 5893 | 6383 | 6874 | 7366 |